

DH-IPC-HFW2531T-ZS/VFS

5MP WDR IR Bullet Network Camera



- 1/2.7" 5Megapixel progressive CMOS
- H.265 & H.264 dual-stream encoding
- 15fps@5M(2592×1944)&25/30fps@3M(2304×1296)
- WDR(120dB), Day/Night(ICR), 3DNR, AWB, AGC, BLC
- Multiple network monitoring: Web viewer, CMS(DSS/PSS) & DMSS
- Micro SD card slot, up to 128GB
- 2.7~13.5mm varifocal lens
- Max IR LEDs Length 60m
- IP67, PoE+



System Overview

The IR Megapixel Vari-focal camera delivers 5MP resolution with a 2.7mm ~ 13.5mm varifocal lens. The camera's elegant blend of aesthetics combined with a range of easy mounting solutions provides an excellent choice for a variety of small to mid-size applications at an affordable price.

Functions

Smart Codec (H.265+ & H.264+)

Smart Codec is the optimized implementation of standard video compression (H.265 & H.264) that uses a scene-adaptive encoding strategy, dynamic GOP, dynamic ROI, flexible multi-frame reference structure and intelligent noise reduction to deliver high-quality video without straining the network. Smart Codec technology reduces bit rate and storage requirements by up to 70% when compared to the standard video compression.

Intelligent Video analysis (IVS)

Dahua camera is equipped with a built-in intelligent analytic algorithm based on video, which can realize intelligent functions like Tripwire and Intrusion, to quickly and accurately respond to monitoring events in specific area. It can enhance monitoring efficiency. In addition, the camera supports intelligent tamper detection, which is to generate warning message via detecting dramatic scene change and to guarantee effective video surveillance.

Wide Dynamic Range (WDR)

The camera achieves vivid images, even in the most intense contrast lighting conditions, using industry-leading wide dynamic range (WDR) technology. For applications with both bright and low lighting conditions that change quickly, true WDR (120 dB) optimizes both the bright and dark areas of a scene at the same time to provide usable video.

Smart IR Technology

With IR illumination, detailed images can be captured in low light or total darkness. The camera's Smart IR technology adjusts the intensity of camera's infrared LEDs to compensate the distance of an object. Smart IR technology prevents IR LEDs from whitening out images as they come closer to the camera. The camera's integrated infrared illumination provides high performance in extreme low-light environments up to 60m (197ft).

Protection (IP67, wide voltage)

The camera allows for $\pm 25\%$ input voltage tolerance, suitable for the most unstable conditions for outdoor applications. Its 2KV lightning rating provides effective protection for both the camera and its structure against lightning. Subjected and certified to rigorous dust and immersion tests (IP67), the camera is the choice for installation in even the most unforgiving environments.

Environmental

Dahua cameras operate in extreme temperature environments, rated for use in temperatures from -30° C to +60° C (-22° F to +140° F) with 95% humidity.

Image flip

Capturing unnecessary data such as surrounding hallway walls can increase storage requirements without any added value. The image flip feature allows the camera's image to be rotated in 90° increments for better video optimization.

Interoperability

The camera conforms to the ONVIF (Open Network Video Interface Forum) specifications, ensuring interoperability between network video products regardless of manufacturer.

Technical Specification

Camera

Image Sensor	1/2.7" 5Megapixel progressive CMOS
Effective Pixels	2592(H) x1944(V)
RAM/ROM	512MB/32MB
Scanning System	Progressive
Electronic Shutter Speed	Auto/Manual, 1/3~1/100000s
Minimum Illumination	0.02Lux/F1.6(Color,1/3s,30IRE) 0.2Lux/F1.6(Color,1/30s,30IRE) 0Lux/F1.6(IR on)
S/N Ratio	More than 50dB
IR Distance	Distance up to 60m(197ft)
IR On/Off Control	Auto/ Manual
IR LEDs	4

Lens

Lens Type	Motorized(-ZS),Manual(-VFS)				
Mount Type	Board-in				
Focal Length	2.7mm~13.5mm				
Max. Aperture	F1.4				
Angle of View	H:95°~27°, V:70°~20°				
Focus Control	Motorized(-ZS),Manual(-VFS)				
Close Focus Distance	0.3m				
DORI Distance	Lens	Detect	Observe	Recognize	Identify
	W	64m(210ft)	26m(85ft)	13m(43ft)	6m(20ft)
	T	222m(728ft)	89m(292ft)	44m(144ft)	22m(72ft)

PTZ

Pan/Tilt Range	Pan:0° ~360° ;Tilt:0° ~90° ;Rotation:0° ~360°
----------------	---

Intelligence

Event Trigger	Motion detection, Video tampering , Scene changing , Network disconnection , IP address conflict, Illegal Access,Storage anomaly
IVS	Tripwire, Intrusion

Video

Compression	H.265/H.264H/MJPEG(Sub Stream)
Smart Codec	Support H.265+/H.264+
Streaming Capability	2 Streams
Resolution	5M(2592x1944)/4M(2688x1520)/3M(2304x1296/2048x1536)/1080P(1920x1080)/720P(1280x720)/D1(704x576/704x480)/VGA(640x480)/CIF(352x288/352x240)
Frame Rate	Main Stream: 5M (1 ~ 15fps)/3M(1 ~ 25/30fps)
	Sub Stream: D1/CIF(1 ~ 25/30fps)
Bit Rate Control	CBR/VBR

Bit Rate	H.265: 12K ~ 8448Kbps H.264: 32K ~ 10240Kbps
Day/Night	Auto(ICR) / Color / B/W
BLC Mode	BLC / HLC / WDR(120dB)
White Balance	Auto/Natural/Street Lamp/Outdoor/Manual
Gain Control	Auto/Manual
Noise Reduction	3D DNR
Motion Detection	Off / On (4 Zone, Rectangle)
Region of Interest	Off / On (4 Zone)
Electronic Image Stabilization(EIS)	N/A
Smart IR	Support
Digital Zoom	16x
Flip	0°/90°/180°/270°
Mirror	Off / On
Privacy Masking	Off / On (4 Area, Rectangle)

Audio

Compression	G.711a/ G.711Mu/ AAC/ G.726
-------------	-----------------------------

Network

Ethernet	RJ-45 (10/100Base-T)
Protocol	HTTP;HTTPS;TCP;ARP;RTSP;RTP;RTCP;UDP;SMTP; FTP;DHCP;DNS;DDNS;PPPoE;IPV4/V6;QoS;UPnP; NTP;Bonjour;IEEE 802.1X;Multicast;ICMP;IGMP;TLS
Interoperability	ONVIF Profile S&G, API
Streaming Method	Unicast / Multicast
Max. User Access	10 Users / 20 Users
Edge Storage	NAS Local PC for instant recording Micro SD Card 128GB
Web Viewer	IE, Chrome, Firefox, Safari
Management Software	Smart PSS, DSS, DMSS
Smart Phone	IOS, Android

Certifications

Certifications	CE (EN 60950:2000) UL:UL60950-1 FCC: FCC Part 15 Subpart B
----------------	--

Interface

Video Interface	N/A
Audio Interface	N/A
RS485	N/A
Alarm	N/A

Electrical

Power Supply	DC12V,PoE+ (IEEE 802.3at)(Class 4)
Power Consumption	<15W(-ZS), <13W(-VFS)

Environmental

Operating Conditions	-30° C ~ +60° C (-22° F ~ +140° F) / Less than 95% RH
Storage Conditions	-30° C ~ +60° C (-22° F ~ +140° F) / Less than 95% RH
Ingress Protection	IP67
Vandal Resistance	N/A

Construction

Casing	Metal
Dimensions	244.1mm×79mm×75.9mm (9.61"×3.11"×2.99")
Net Weight	0.815kg (1.80lb)
Gross Weight	1.08kg (2.38lb)

Ordering Information

Type	Part Number	Description
4MP camera	DH-IPC-HFW2531TP-ZS	5MP WDR IR Bullet Network Camera, PAL
	DH-IPC-HFW2531TN-ZS	5MP WDR IR Bullet Network Camera, NTSC
	IPC-HFW2531TP-ZS	5MP WDR IR Bullet Network Camera, PAL
	IPC-HFW2531TN-ZS	5MP WDR IR Bullet Network Camera, NTSC
	DH-IPC-HFW2531TP-VFS	5MP WDR IR Bullet Network Camera, PAL
	DH-IPC-HFW2531TN-VFS	5MP WDR IR Bullet Network Camera, NTSC
	IPC-HFW2531TP-VFS	5MP WDR IR Bullet Network Camera, PAL
	IPC-HFW2531TN-VFS	5MP WDR IR Bullet Network Camera, NTSC
Accessories (optional)	PFA130-E	Junction box
	PFA152-E	Pole mount

Accessories

Optional:



PFA130-E
Junction Box



PFA152-E
Pole Mount

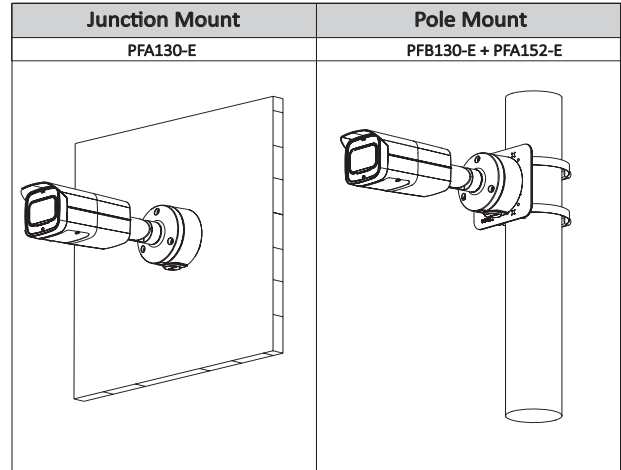

Dimensions (mm/inch)

